



NEW!

NEO TP500

SPA CONTROL TOUCHSCREEN



NEO 2100
Spa Control



NEO TP500 TouchScreen

FEATURES:

- Android Based Control Panel
- 5.0" TouchScreen
- Capacitive Touch Technology
- Easy to read and scroll icons
- Easy menu navigation
- Pinch & Stretch views
- Ultra bright for daylight use
- Organized device functions and App displays
- Full internet access
 - YouTube
 - Streaming videos
 - Search engines

CONTAINS:

- Built-in WiFi
- Optional HDMI
- Optional Bluetooth (when installed in control unit)

NEO TP500 TouchScreen

Part No.	Description	List (US \$)
777-WW06000	NEO TP500 Touch Panel	963.05



The standard in Spa Control performance.

NEO 2100 SPA CONTROL SYSTEM

One innovative system that offers **64 different configurations!**



- External equipment & topside panel connections
- Modular equipment expansion
- Toggle terminal connection
- Electronic Thermal Sensing (ETS) system
- Equipment converts 220V to 120V
- Converts from 60 Hz to 50 Hz
- Wi-Fi & Bluetooth option
- Topside features a 1.8" color LCD display
- Panel back light w/White LED or optional RGB LED
- Easy menu navigation
- Multi languages (English, French, Spanish, German, Norwegian, Italian)
- Real-time clock
- AUX panel ready
- Accepts NEO 2100, NEO 1100 or NEO 1000 topside panels
- Accepts NEO TP500 TouchScreen



Spa Controls

NEO 2100 Spa Control with Panel

Part No.	Description	List (US \$)
777-WW99001	NEO 2100 Control Kit, 2-2 Spd Pumps, Blwr, 03, AV 4.0Kw Htr. W/ NEO 1100 Panel	1,209.99
777-WW99002	NEO 2100 Control Kit, 2-2 Spd Pumps, Blwr, 03, AV 5.5Kw Htr. W/ NEO 1100 Panel	1,209.99
777-WW99003	NEO 2100 Control Kit, 2-2 Spd Pumps, Blwr, 03, AV 4.0Kw Htr. W/ NEO 2100 Panel	1,231.64
777-WW99004	NEO 2100 Control Kit, 2-2 Spd Pumps, Blwr, 03, AV 5.5Kw Htr. W/ NEO 2100 Panel	1,231.64

NEO 2100 Spa Control with Retro Kit & Panel

777-WW99050	NEO 2100 Control Kit w/Retro Kit*— 2-2 Spd Pumps, Blwr, 03, AV 4.0 kW Htr. w/NEO 1100 Panel	1,344.93
777-WW99051	NEO 2100 Control Kit w/Retro Kit*— 2-2 Spd Pumps, Blwr, 03, AV 5.5 kW Htr. w/NEO 1100 Panel	1,344.93
777-WW99052	NEO 2100 Control Kit w/Retro Kit*— 2-2 Spd Jet, Blwr, 03, 4.0 kW Htr. w/NEO 2100 Panel	1,366.58
777-WW99053	NEO 2100 Control Kit w/Retro Kit*— 2-2 Spd Jet, Blwr, 03, 5.5 kW Htr. w/NEO 2100 Panel	1,366.58

*includes 780-8020 Retro Kit (Adapter Plate, Light Lead, 2-2 Spd & 1-1 Spd 4 Ft. 4 Pin Amp Cords)

Accessories / Replacements

775-0501	Daughter Board 1 (DB-1) (allows for up to 2 add'l 1 Spd Pumps or 1 add'l 2 Spd Pump)	151.59
775-0502	Daughter Board 2 (DB-2) (allows for up to 4 add'l 1 Spd Pumps or 2 add'l 2 Spd Pumps)	246.32
780-8020	EO 2100 Retro Kit – Adapter Plate, Light Lead, 2-2 Spd & 1-1 Spd 4 Pin Amp Cords	134.94
775-0504	Wi-Fi Kit Assembly	441.50
775-0523	Bluetooth Kit	257.54
777-WW02007	AUX 1000 Panel (4 buttons, Light, Aux, Jet1, Jet2)	123.80

Accessory Breakdown for 780-8020

633-1000	Light Lead W/2-Pin Connector	13.13
741-CGGG-45X	Power Cord, 4 Ft. 4 Pin-Amp, 2 Speed	30.31
741-CGGZ-44X	Power Cord, 4 Ft. 4 Pin-Amp, 1 Speed	28.43
885-8020	Adapter Plate – Spa Pack NEO 2100	35.05



Spa Control System / NEO 1500 Spa Control

Value Spa Control for less complex systems.

NEO 1500 SPA CONTROL SYSTEM

Available with
multiple configurations!

- More than 64 different configurations
- Electronic Thermal Sensing (ETS) system
- 240V – 120V convertible
- Available in 50 Hz or 60 Hz
- Topside features a 1.8" color LCD display
- Panel back light w/White LED
- Accepts dedicated 230V w/out Neutral
- Wi-Fi option
- Bluetooth option
- Easy menu navigation
- Multi languages (English, French, Spanish, German, Norwegian, Italian)
- Optional Daughter Board (DB1)
- Accepts NEO 2100, NEO 1100 or NEO 1000 topside panels
- Accepts NEO TP500 TouchScreen



UL certified for the US & Canada
CE compliant for Europe



NEO 1500 Spa Control

Part No.	Description	List (US \$)
777-WW99013	NEO 1500 Control Kit, 1-2 Spd Pump1, 1-1 Spd Pump 2 or Blwr, O3, AV, 3.0 kW Htr, w/NEO 1000 Panel	1,134.18
777-WW99014	NEO 1500 Control Kit, 1-2 Spd Pump1, 1-1 Spd Pump 2 or Blwr, O3, AV, 4.0 kW Htr, w/NEO 1000 Panel	1,134.18
777-WW99015	NEO 1500 Control Kit, 1-2 Spd Pump1, 1-1 Spd Pump 2 or Blwr, O3, AV, 5.5 kW Htr, w/NEO 1000 Panel	1,134.18
777-WW99010	NEO 1500 Control Kit, 1-2 Spd Pump1, 1-1 Spd Pump 2 or Blwr, O3, AV, 3.0 kW Htr, w/NEO 1100 Panel	1,134.18
777-WW99011	NEO 1500 Control Kit, 1-2 Spd Pump1, 1-1 Spd Pump 2 or Blwr, O3, AV, 4.0 kW Htr, w/NEO 1100 Panel	1,134.18
777-WW99012	NEO 1500 Control Kit, 1-2 Spd Pump1, 1-1 Spd Pump 2 or Blwr, O3, AV, 5.5 kW Htr, w/NEO 1100 Panel	1,134.18
775-0501	Daughter Board (DB1) (allows for up to 2 additional 1 Spd Pumps or 1 add'l 2 Spd Pump	151.59
775-0503	Bluetooth Kit Assy (Includes screw & stand-off)	257.54
775-0504	Wi-Fi Kit Assembly (No added monthly fees.)	441.50



The standard in Spa Control performance.

NEO 1200

SPA CONTROL SYSTEM

Compact design for **easy installation** in tight locations.

- Plug and Play
- Electronic Thermal Sensing (ETS) system
- Available in 120V / 60 Hz or 220V / 50 Hz
- Bluetooth ready
- Topside features a 1.8" color LCD display
- Panel back light w/White LED
- Bluetooth option
- Easy menu navigation
- Multi languages (English, French, Spanish, German, Norwegian, Italian)
- Small Compact Housing
- Optional 15 Ft 15 Amp GFCI power cords (60 Hz only)
- Accepts NEO 1100 or NEO 1000 topside panels



UL **US** **CE**
 UL certified for the US & Canada
 CE compliant for Europe

Spa Controls

NEO 1200 Spa Control		
Part No.	Description	List (US \$)
777-WW99022	NEO 1200 Control Kit, 1-2 Spd Pump, 03, Lt, 1 kW Htr, w/NEO 1000 Panel	1,058.40
777-WW99023	NEO 1200 Control Kit, 1-2 Spd Pump, 03, Lt, 1 kW Htr, w/NEO 1000 Panel & 120V 15' at 15A GFCI Pwr Cord	1,152.54
777-WW99020	NEO 1200 Control Kit, 1-2 Spd Pump, 03, Lt, 1 kW Htr, w/NEO 1100 Panel	1,058.40
777-WW99021	NEO 1200 Control Kit, 1-2 Spd Pump, 03, Lt, 1 kW Htr, w/NEO 1100 Panel & 120V 15' at 15A GFCI Pwr Cord	1,152.54
775-0503	Bluetooth Kit Assy (Includes screw & stand-off)	257.54



Spa Control System / NEO Topside Panels & Accessory Dimensions

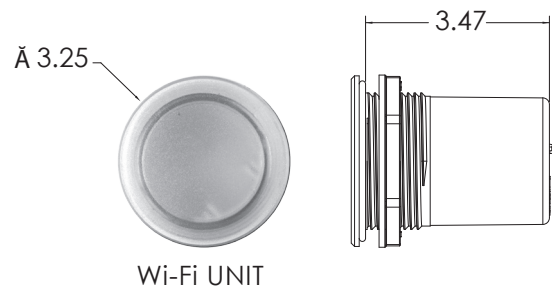
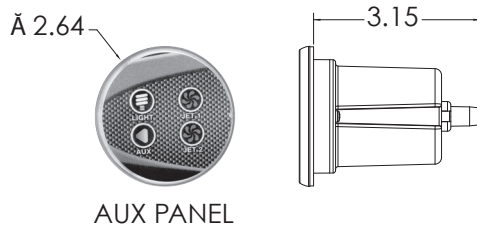
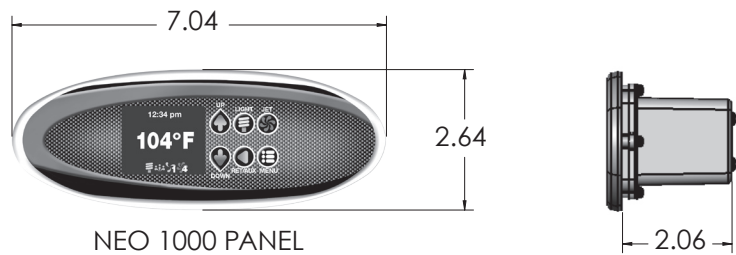
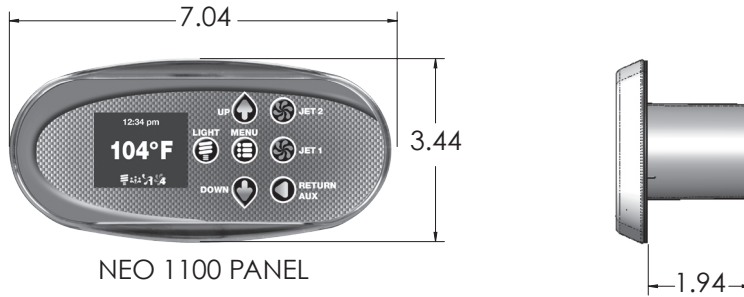
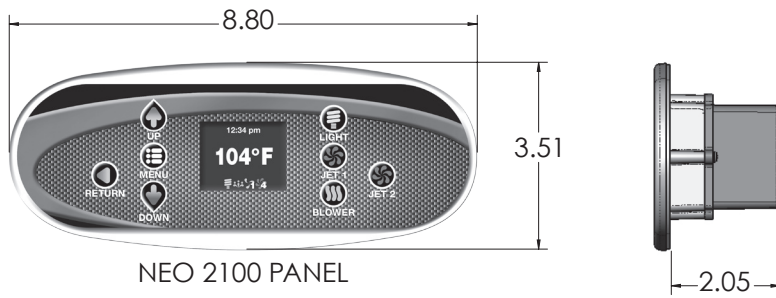
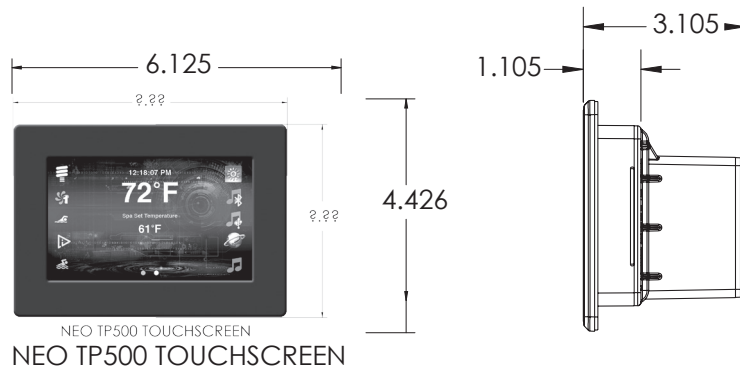



FEATURES:

- Latest speaker design with Titanium tweeter
- LED capable
- Dampening device
- Pop-up design

Standard Features:

- Dampened speaker lift
- Front and back LED ports
- 30% more compact than previous models

Options:

- Multiple lighting options
- Front ambient light
- Lit logo (call for details)
- Lit ring with Glo Tubes (requires rotation ring and nut)

SPECIFICATIONS:

- 15 W RMS / 30 W Peak
- Impedance: $4 \Omega \pm 15\% \Omega$
- Resonant Frequency: 110 Hz $\pm 20\%$ Hz
- SPL: 70 dB ± 3 dB ref 1 W/1M
- Frequency Response: ~20 KHz, max ± 10 dB

Magna Tune

Compact Design
30% shorter than previous model

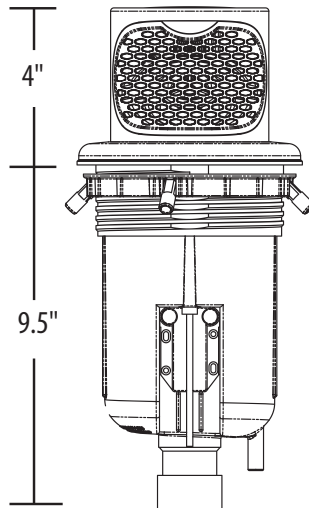

675-2010
675-2010L

Speakers

Magna Tune 6" Pop-Up Silo Speaker System

Part No.	Description	List (US \$)
675-2020L	Magna Tune pop-up speaker (Non-rotational) LED	200.77

Note: For metal grill add "s" to the part number suffix.

Mounting Specifications

	Non-Rotational Cap
Hole size	4 3/4"
Closed height	3/8"
Flange OD	5 5/8"

Speaker depth from flange: 9 3/4"