

# SANTANNA AIR BLOWER INSTRUCTIONS



**IMPORTANT SAFETY INSTRUCTIONS • SAVE THESE INSTRUCTIONS • PLEASE READ AND FOLLOW ALL INSTRUCTIONS**

When installing and using this electrical equipment, basic safety precautions should always be followed, including the following:

1. (For all units) Install to provide drainage of compartment for electrical components.
2. (For all units) **WARNING** - To reduce the risk of injury, do NOT permit children to use this product unless they are closely supervised at all times.
3. (For permanently installed units only) A green colored wire (or a wire connector marked "G", "GR", "Ground", or "Grounding") is provided with the switch box. To reduce the shock, connect this terminal or connector to the grounding terminal of your electric service or supply panel with a continuous green insulated copper wire equivalent in size to the circuit conductors supplying this equipment, but no smaller than No. 12AWG (3.3mm<sup>2</sup>).
4. (For assemblies with air blowers) Install in accordance with Diagram 1 to keep spa or water out of electrical equipment.
5. The unit must be installed within a suitable enclosure to restrict user access to the equipment or connections and be of an enclosure type that will provide an ingress protection rating of IP24 or better.

## BLOWER SIZING - AIR CHANNELS, AIR BARS, AIR CAPS, & AIR RINGS

Choosing the proper size of air blowers is critical for maximum performance and extended motor life. To determine the correct blower size for a spa or hot tub, these elements must be considered: 1. Water depth, 2. The number of air holes.

### WATER DEPTH

1. Total length of 2" pipe from blower to spa. For each 10 feet of 2" air line, add 1" to water depth.
2. Number of 90 degree angles used in the air line. For each 90 degree angle, add ½" to water depth.
3. Actual water depth (not total depth of spa).

For example: (refer to Diagram 1)

**TABLE 1**

Part No.	HP	Volts	Amps	CFM	Up To
750-1011-280	1.0	110	6.5	115	35
750-1022-280	1.0	220	3.6	113	35
750-1511-280	1.5	110	7.6	120	
750-1522-280	1.5	220	4.0	108	
750-2011-280	2.0	110	9.0	128	
750-2022-280	2.0	220	5.0	119	

1. Air line is 30ft., all inclusive ..... add 3"
  2. Five 90 degree turns ..... add 2 ½"
  3. Actual water depth ..... add 32"
- Total ..... 37 ½"

## NUMBER OF AIR HOLES

The air holes in the spa floor and/or seat release the air perpetuated by the blower through the 2" air line. Table 2 below gives the most common air hole sizes and the corresponding number of air holes needed to release the proper amount of air. An inadequate number of holes or holes that are too small create excessive heat buildup, commonly called back up pressure, resulting in potential harm to the air blower.

**TABLE 2**

Air Hole Size	Decimal Equivalent	No. of Air Holes	Total Orifice Diameter
1/8"	.0123	120	1.370
5/32"	.0192	73	1.336
3/16"	.0276	50	1.325
¼"	.0491	30	1.369

If it is determined that the existing hole sizing is incorrect, additional holes may be drilled or the existing holes may be enlarged or more air injectors added. **CAUTION: Be extra careful not to drill through the bottom of the air channel on your spa.**

## BLOWER SIZING - JETS

Originally designed for air channel aeration, the air blower also has been applied to boost spa jet turbulence. However, to be effective, care must be taken in installing (jets, jet orifice size, pump sizing, length of pipe run, etc.). No common formula for sizing has been found 100% effective. Table 3 is a general guideline, assuming an average pipe run of 15 to 25 feet total. The "bigger is better" idea will definitely not provide a trouble-free installation.

**TABLE 3**

No. of Jets	Blower Size
4-7	1 HP
8-13	1 ½ HP
14 +	2 HP

When sized with the proper circulation pump, the spa jet draws and mixes the proper amount of air and water, thereby eliminating the need of additional boost. Improper jet performance is seldom corrected with the air blower. The Amperage Test (see other side) should always be applied in this situation to assure no costly call-backs.

**IMPORTANT NOTE:** To keep water from entering the blower, causing potential damage, a check valve (P/N 600-8140) and a Hartford loop (refer to Diagram 1) must be used when plumbing blower to jets.



2200 East Sturgis Road, Oxnard, CA 93030 • Ph. (805) 981-0262 • Fax (805) 981-9403  
 www.waterwayplastics.com • waterway@waterwayplastics.com

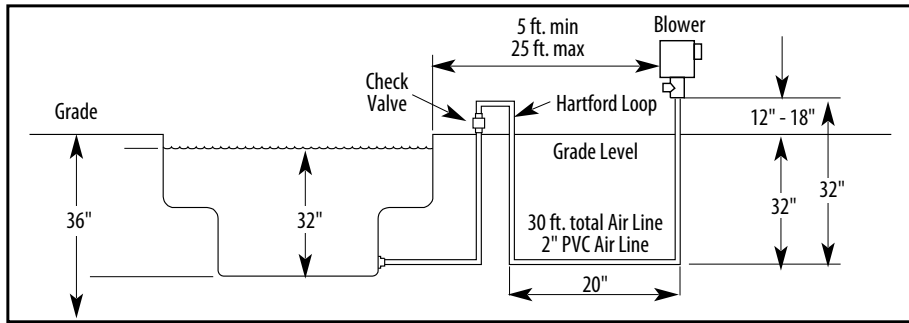

DIAGRAM 1

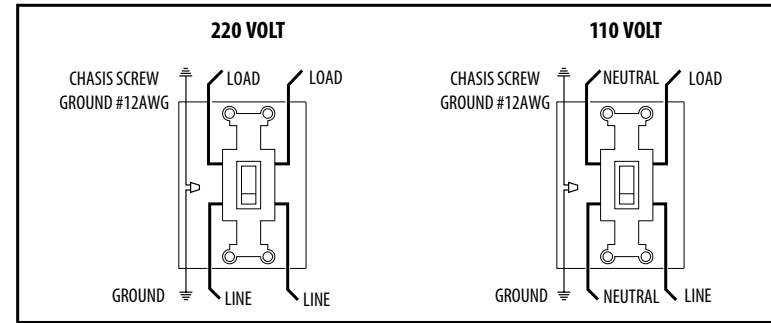

DIAGRAM 3

## RECOMMENDATIONS

1. When possible, install two 45-degree angles to create a right angle rather than one 90-degree angle.
2. Be sure to install the loop (see installation section) a minimum of 12" to 18" above spa level.
3. Use a check valve in every system.

## TYPICAL INSTALLATION OF THE BLOWER

By following the installation recommendations listed below you will be assured of optimum performance and a long lasting installation. Blower model numbers starting at 750 offer the option of side or bottom air discharge. They are supplied with plug for mounting. An external anti-surge valve (sold separately) can be used to prevent potential water backflow to the blower.

When using the side discharge, screw the plug to a solid base using the (3) screw holes provided (see Diagram 2). Apply a small amount of silicone to the vertical wall of the plug and set the blower housing on the plug. If gluing is necessary, spot glue only.

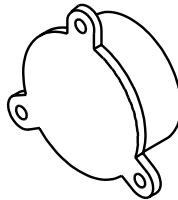

DIAGRAM 2

For bottom discharge, the 2" pipe may be used as the blower support. Be sure to keep the blower 12" to 18" above water level and use the Hartford loop system with a check valve (see Diagram 1). Again, a bead of silicone around the pipe will hold the unit firmly in place.

## ELECTRICAL HOOKUP (SEE DIAGRAM 3)

1. Check the line voltage to be sure it is correct for the air blower being used.
2. DO NOT connect 220 volt line to 110 volt unit. THIS WILL DESTROY YOUR BLOWER.
3. If switch is used, install as illustrated. If switch is not used, tie one line to one load, tie the other line (or neutral) to the other load.
4. GROUND ALL UNITS.
5. ADDITIONAL GROUNDING NOTE: Double insulated (plastic) blowers do not need to be bonded.
6. If the supply cord is damaged, it must be replaced by the manufacturer, its service agent or similarly qualified person in order to avoid a hazard.

## AMPERAGE TEST FOR SPOT CHECKING INSTALLATION

To insure a properly installed and sized air blower, complete the following test. Pull the blower off the pipe, start the unit, and read the amperage. Set blower back on the pipe, start the unit, wait for air channel to clear, and read amperage again. A properly installed unit will not drop more than .5 amps. If the amperage is not to within the range, refer to Troubleshooting or Sizing sections.

## TROUBLESHOOTING

### NO ACTION OR TOTAL MOTOR FAILURE

1. Check motor brushes for excessive wear.
2. Check wiring (i.e. voltage, amperage, etc.)
3. Check for blockage in plumbing.
4. Be sure sizing is correct.
5. Be sure check valve is installed properly.

### BLOWER OVERHEATING

1. Check for blockage in plumbing.
2. Be sure sizing is correct.
3. Be sure check valve is installed properly.

### WATER DAMAGE

1. Check valve may be failing.
2. Sprinklers close to air blowers causing water entry through air intake.
3. Blower installed below water level.
4. Blower installed upside down.

# TYPICAL INSTALLATION SUGGESTIONS

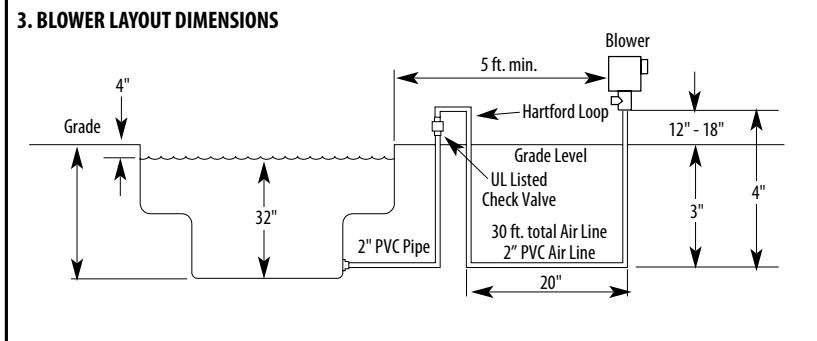
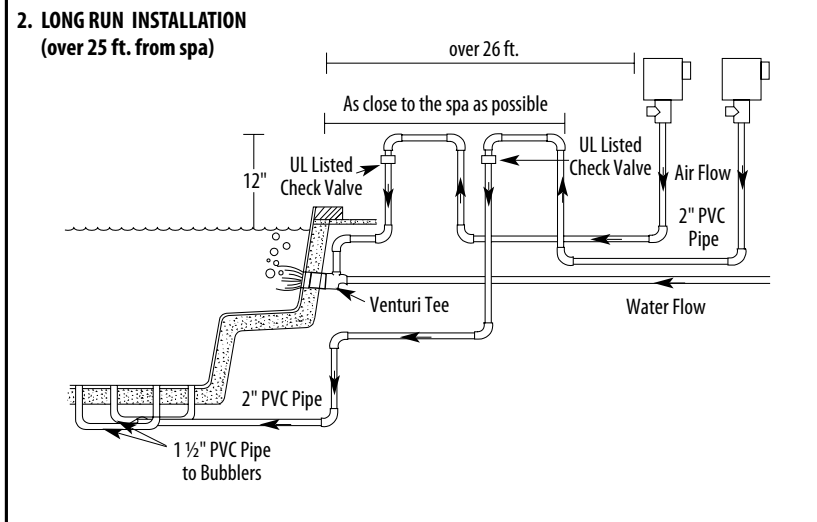
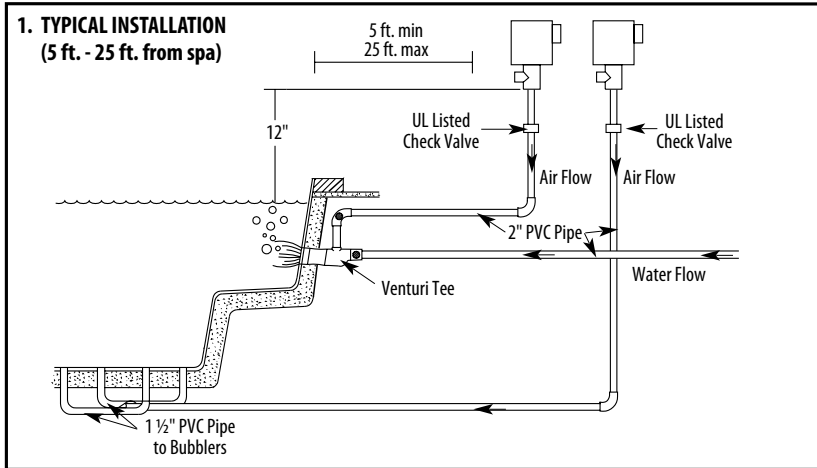

# AIR BLOWER ENHANCEMENT

How an Air Blower enhances the performance of your spa:

**JET ACTION ONLY**

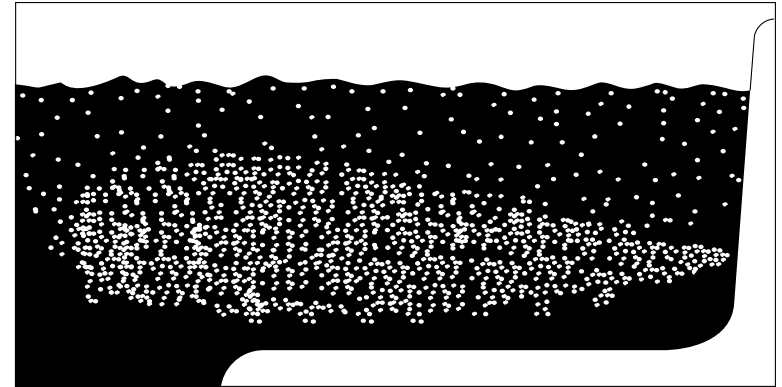

**TOTAL AIR ACTION**

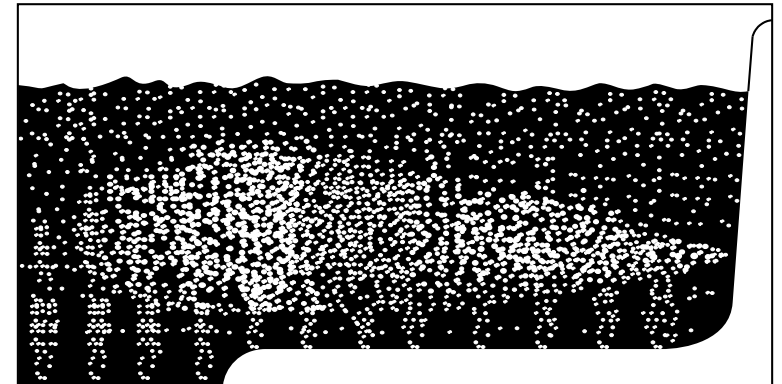

## LIMITED WARRANTY

To all its original purchasers of its products, Waterway, 2200 E. Sturgis Road, CA 93030, warrants its products free from defects in materials and workmanship from a period of one year from the date of purchase. Products which fail or become defective during the warranty period, except as a result of freezing, accident, negligence, improper installation, use, or care, shall be repaired or replaced at our option, without charge within 90 days of receipt of defective product, barring unforeseen delays. To obtain warranty replacements or repair, defective products should be returned, transportation paid, to the place of purchase, or to Waterway. Waterway shall not be responsible for cartage, removal and/or reinstallation labor, or any other such costs incurred in obtaining warranty replacements. Some states do not allow a limitation on how long an implied warranty lasts, or the exclusion or limitation of incidental or consequential damages, so the above limitation or exclusion may not apply to you. This warranty gives you specific legal rights, and you may also have other rights which vary from state to state.

# INSTALLING THE GUNITE AIR INJECTOR CAP

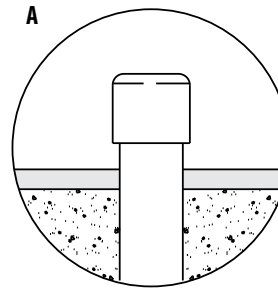
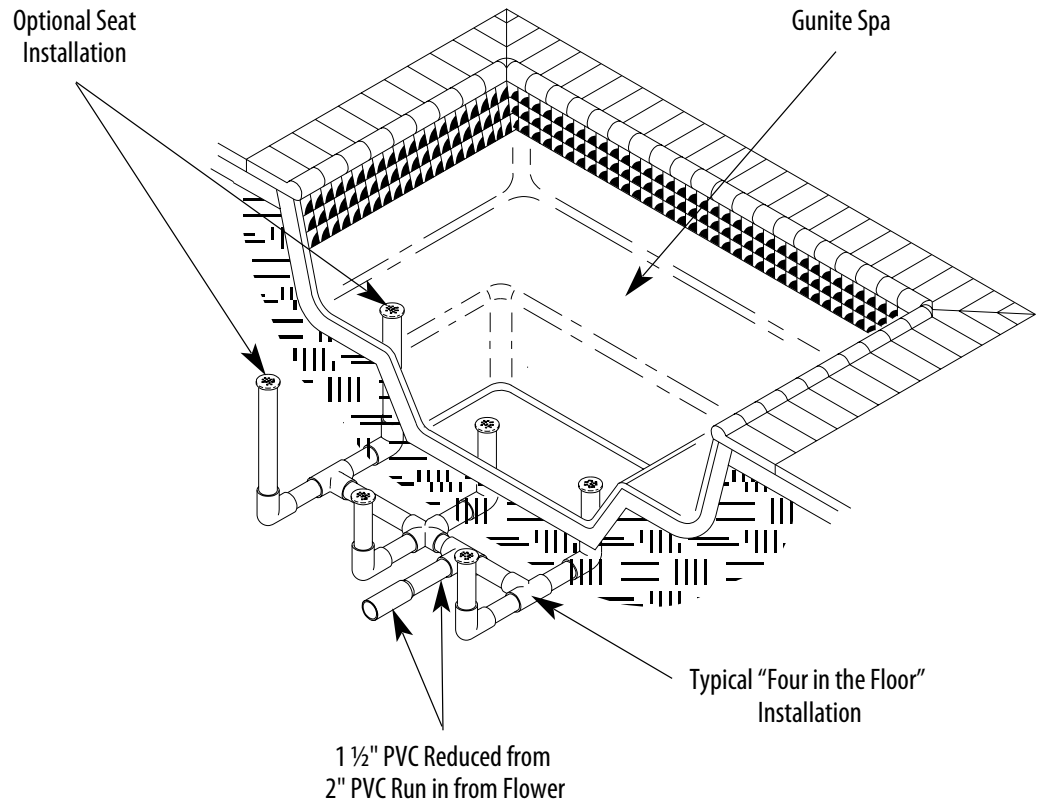
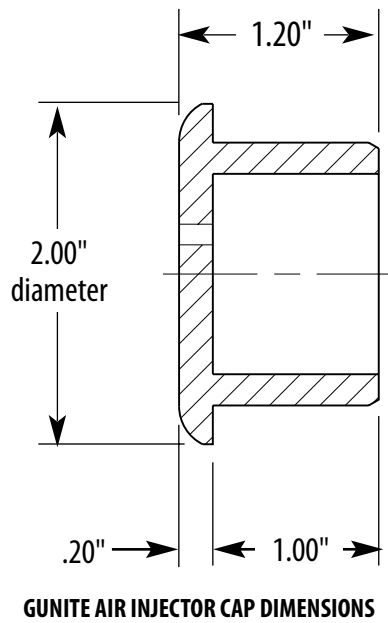
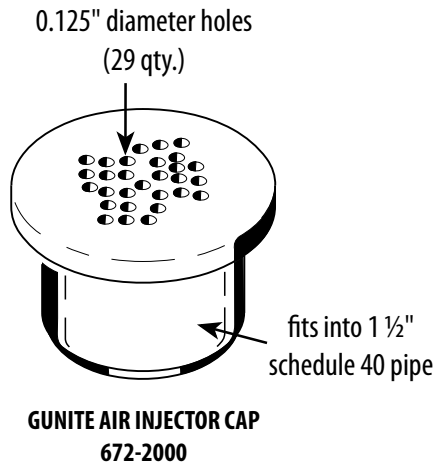

**1 1/2" pipe, capped, stubbed**

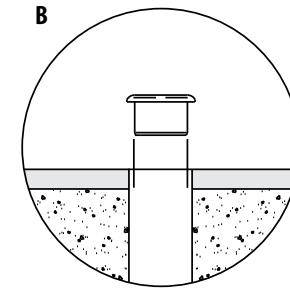

**Fits in 1 1/2" Schedule 40 PVC pipe.  
Pipe cuts flush with finish coat,  
ready for gunite air injector.**